

SINGER
191K11,K12,K13

ILLUSTRATED
LIST OF PARTS
FOR
Nos. 191K11 to 191K13
MACHINES

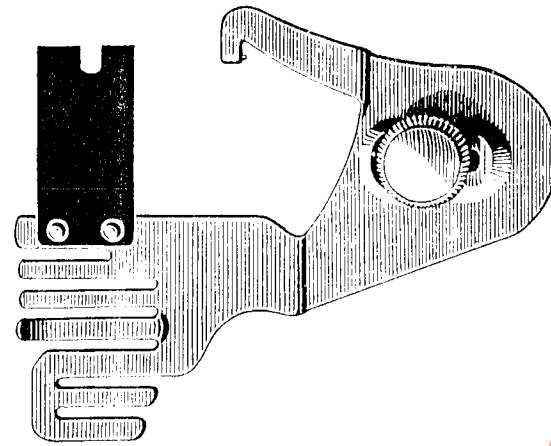

121170



121547

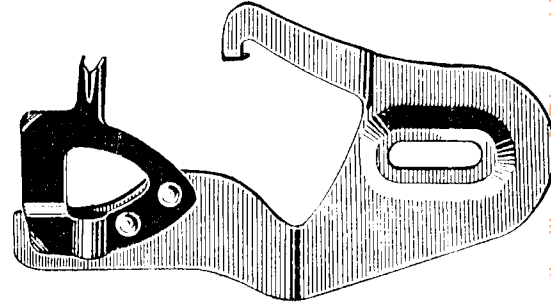

From the library of: Diamond Needle Corp

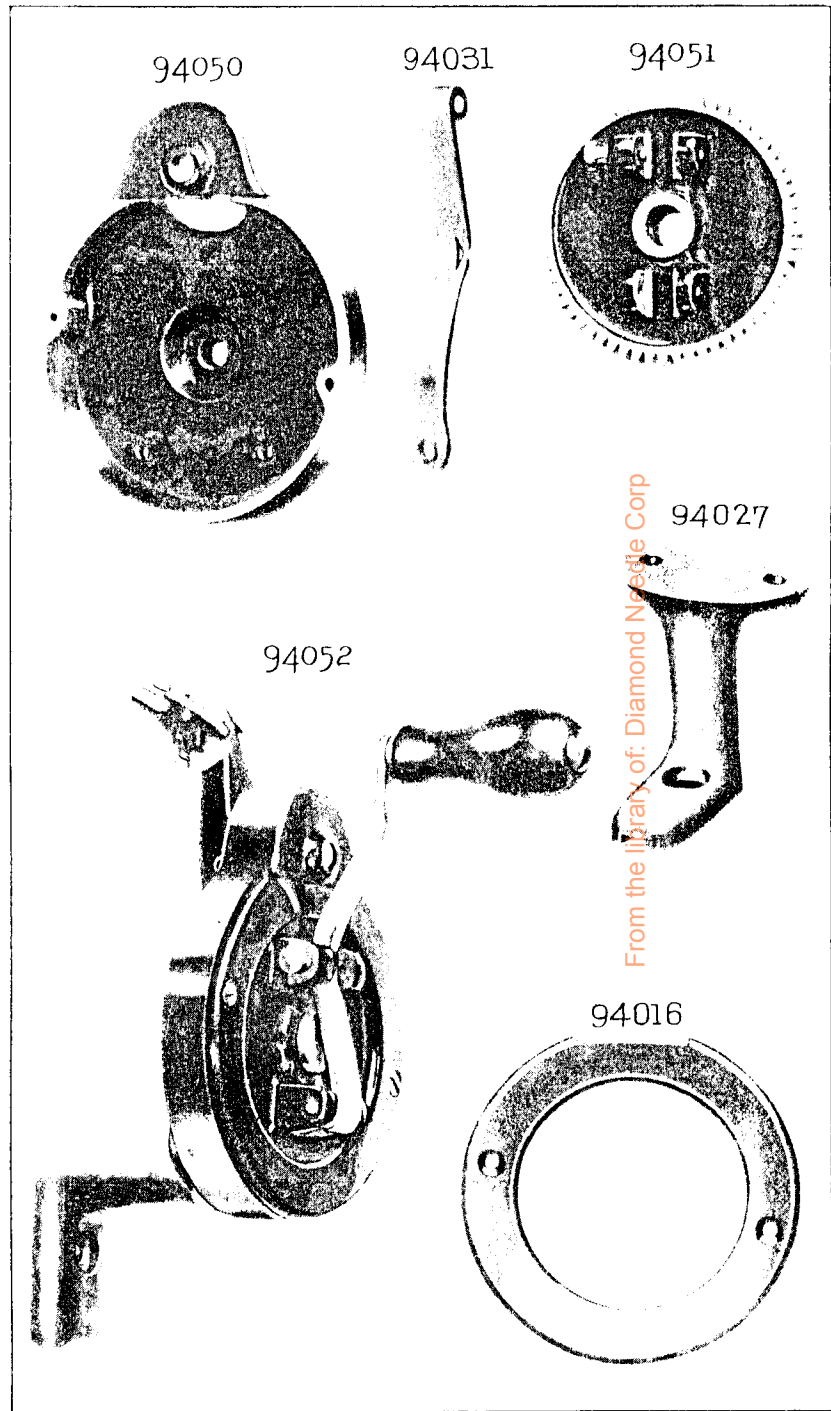
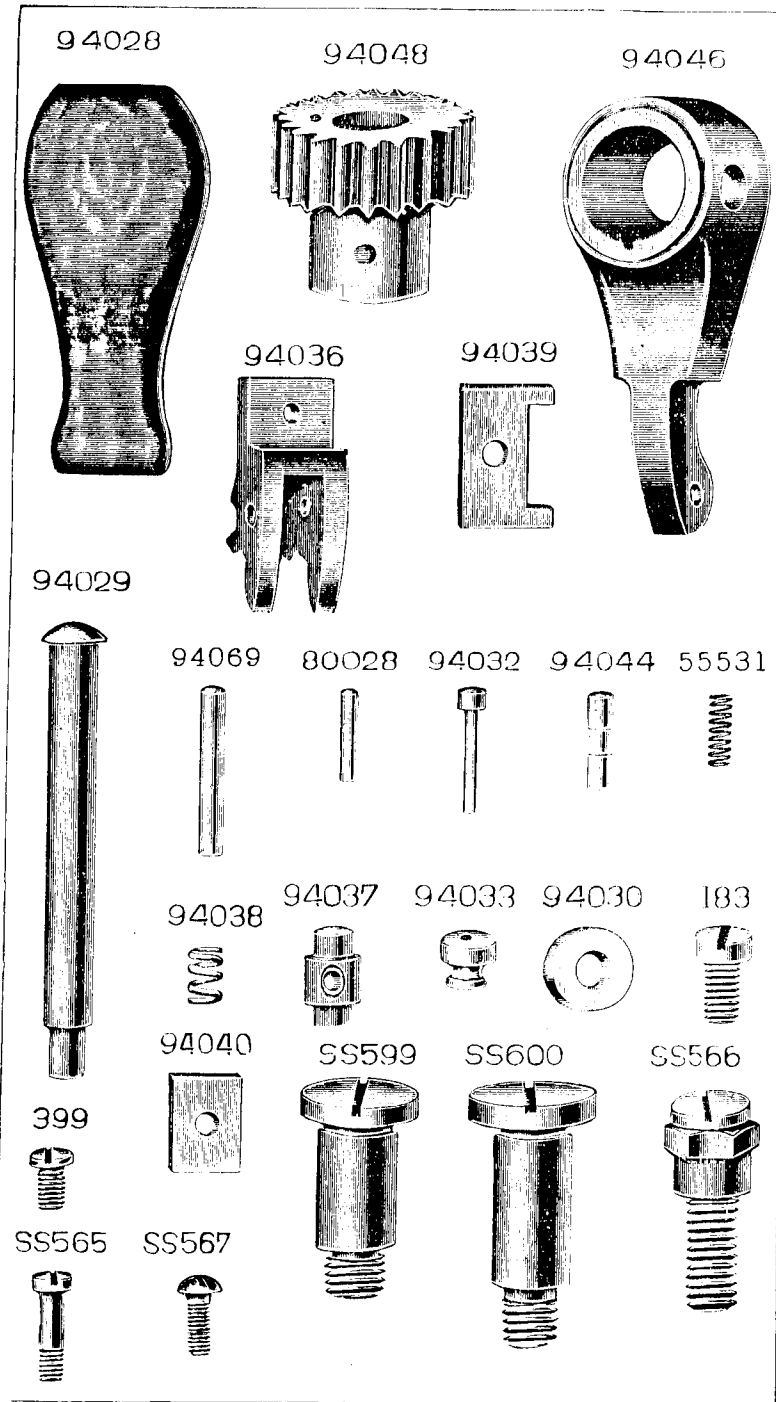

SS528



96425



96426



96844



96427



96845



MW95



160

86742

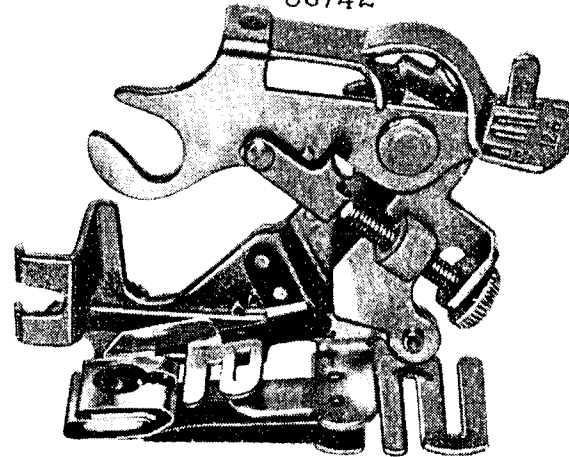

121441



36865

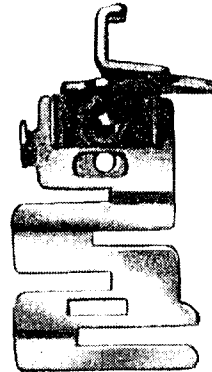

121464

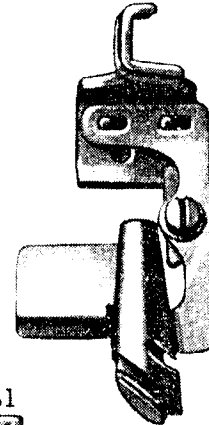

161295



161294

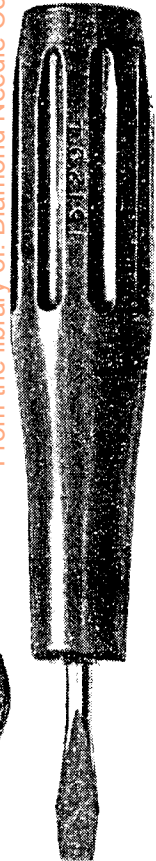

From the library of: Diamond Needle Corp

35931

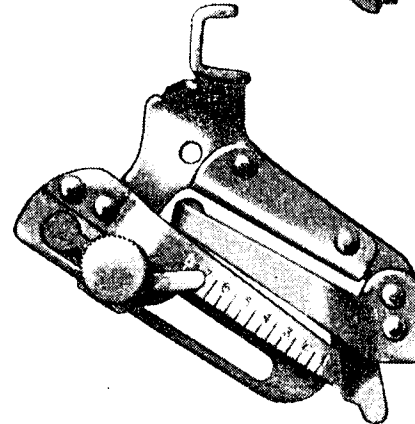

8879

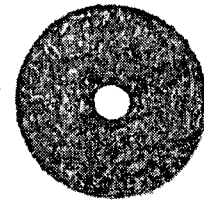

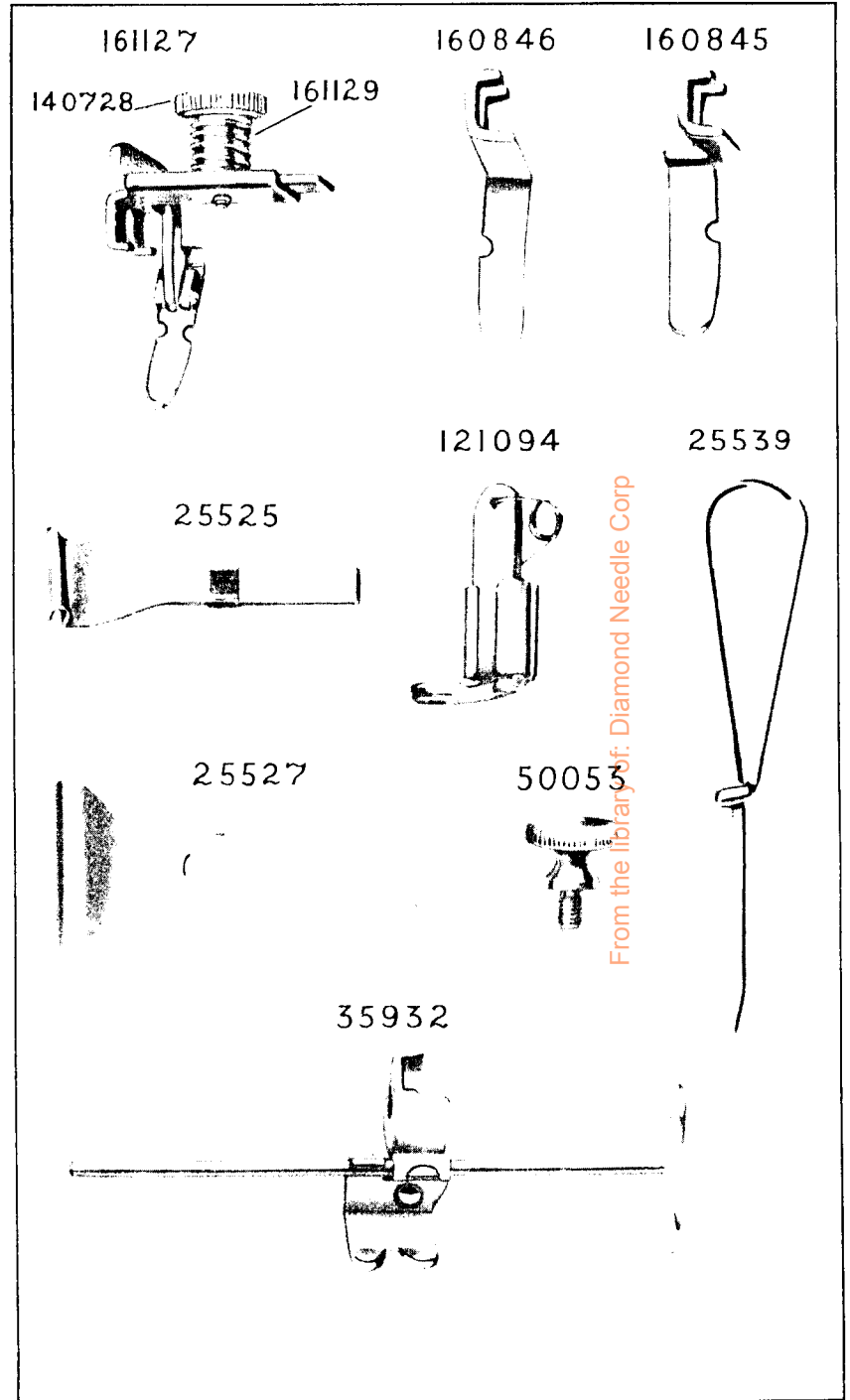
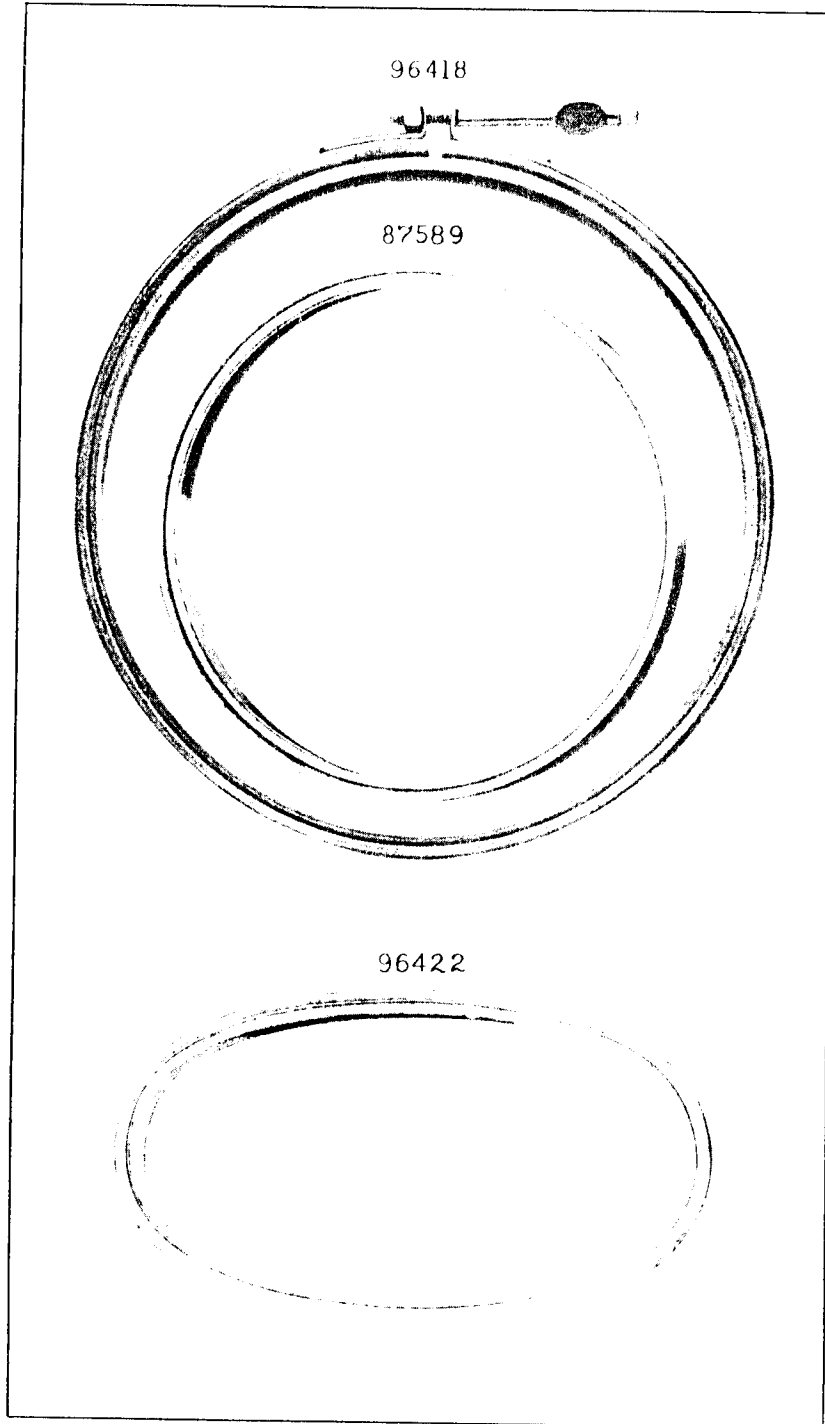

120855

120914

85893

36583



120687

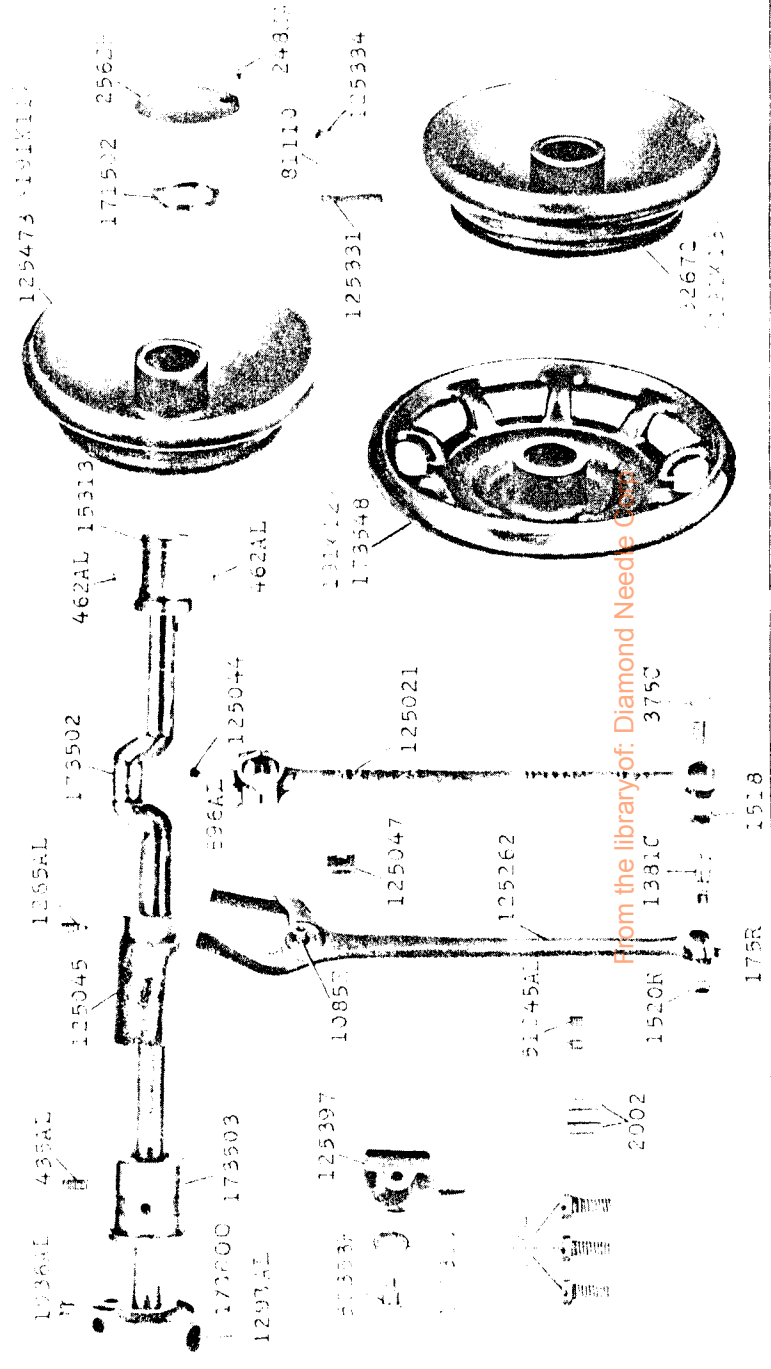
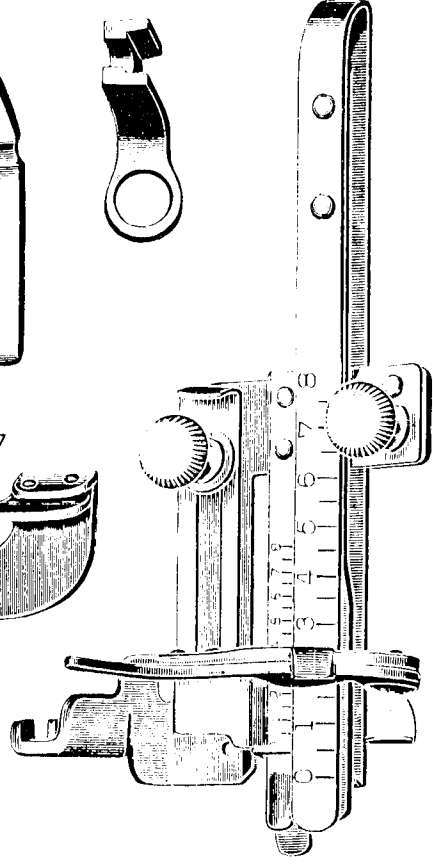
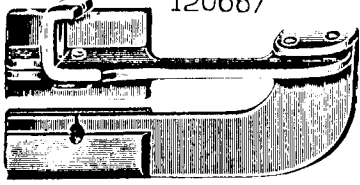

129473 191K117

174502 25600

81110 2+8.00

125331 125334

3267C

462AL 15313

+62AL

1316127

173548

1255AL

173502

125044

125021

433AL

125045

173503

125397

10850

125262

51145AL

2002

1381C

375C

175R

1518

From the library of: Diamond Needle Co.

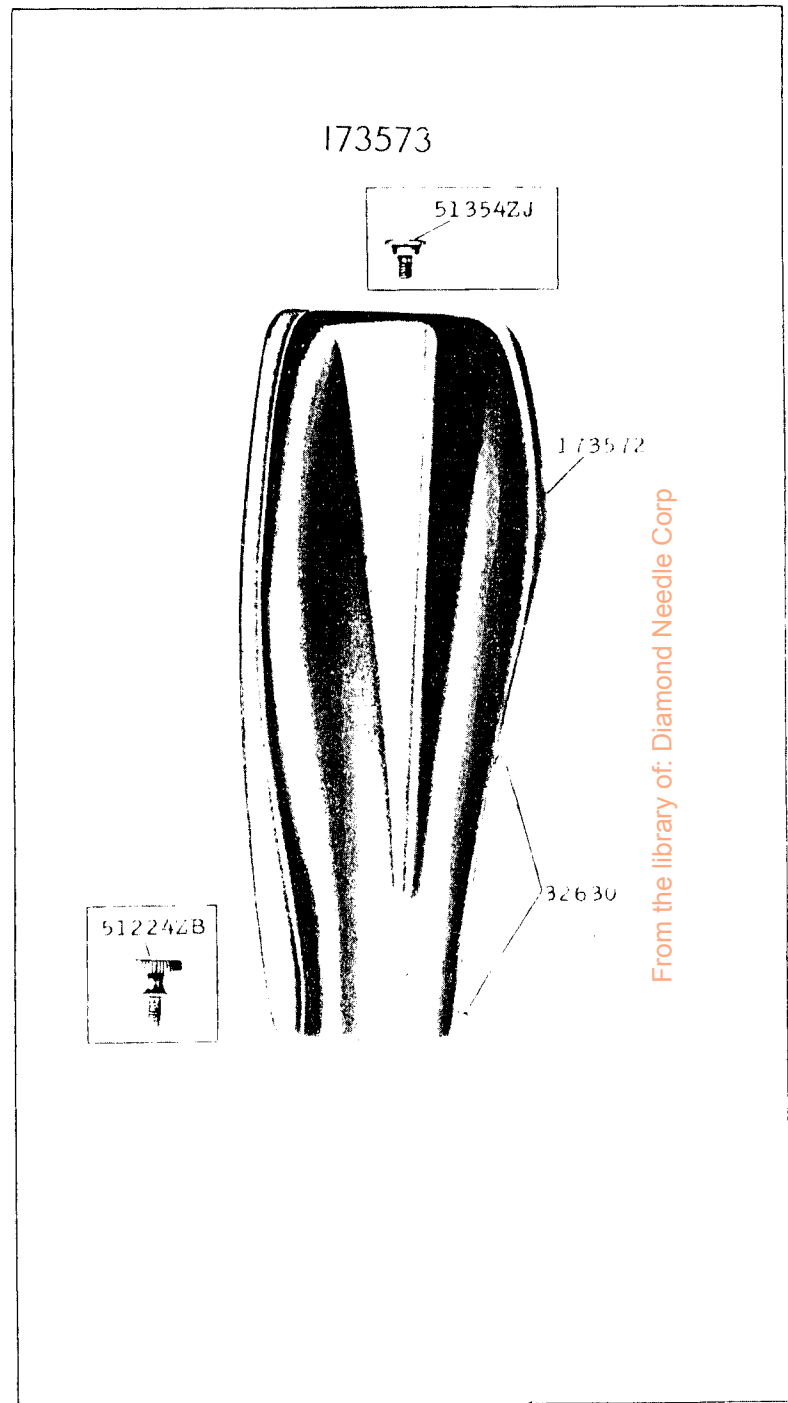
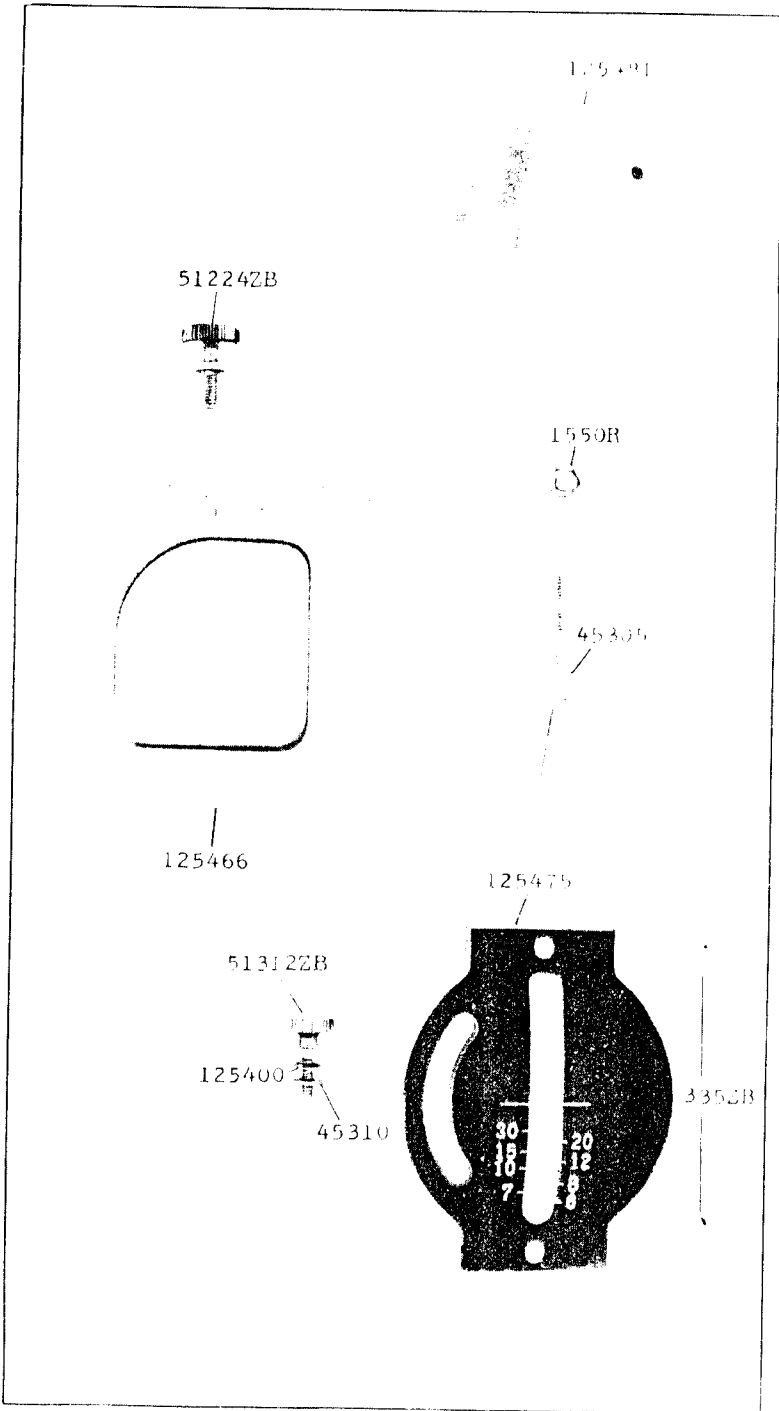

From the library of: Diamond Needle Corp

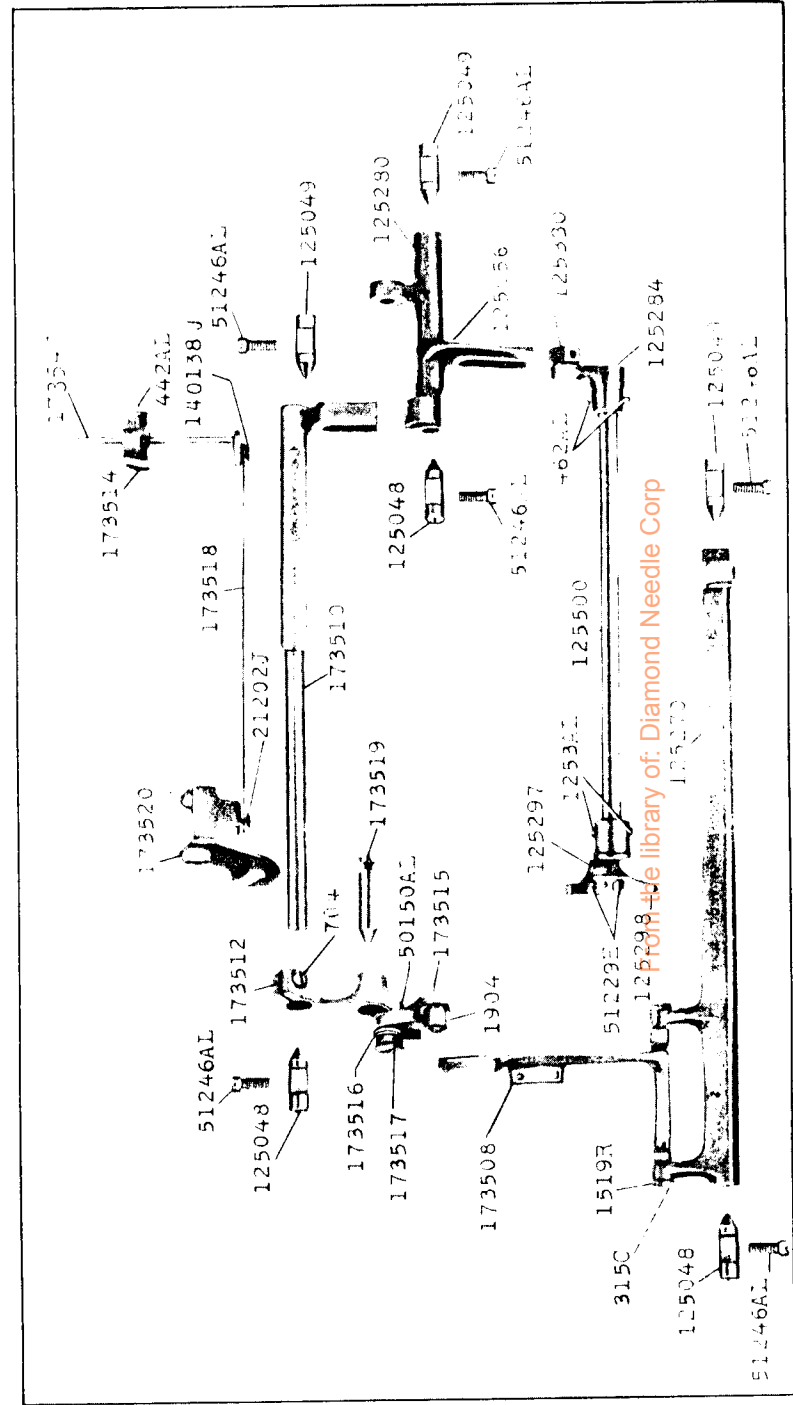
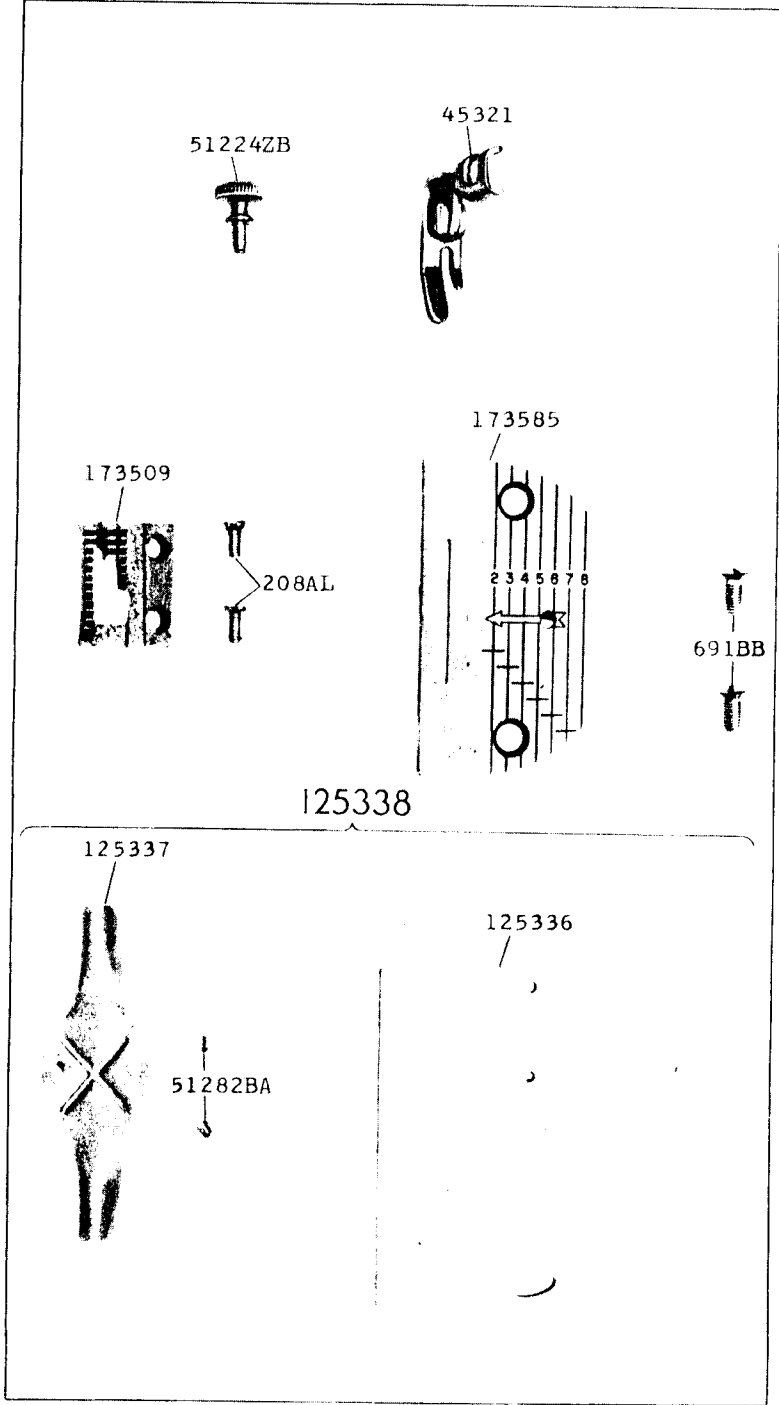

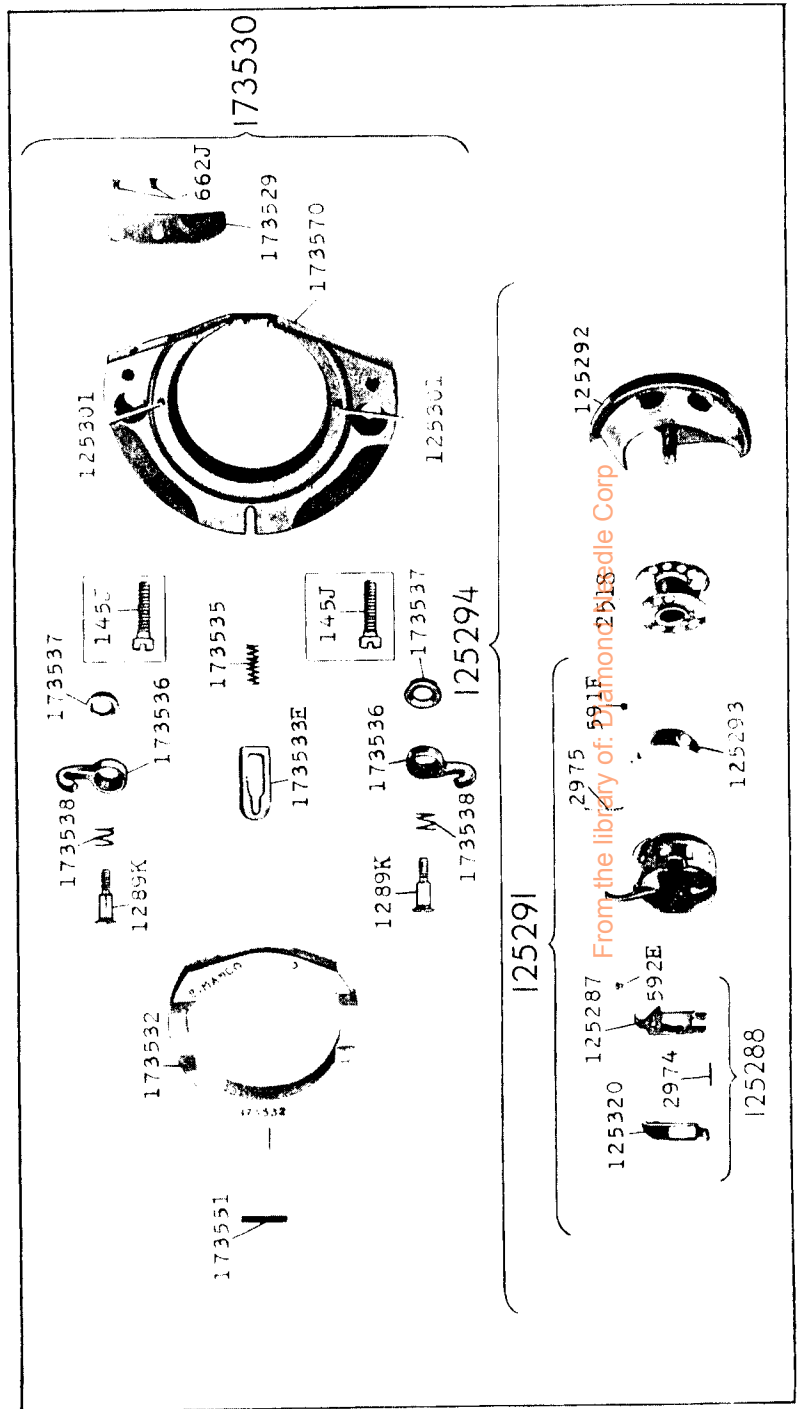
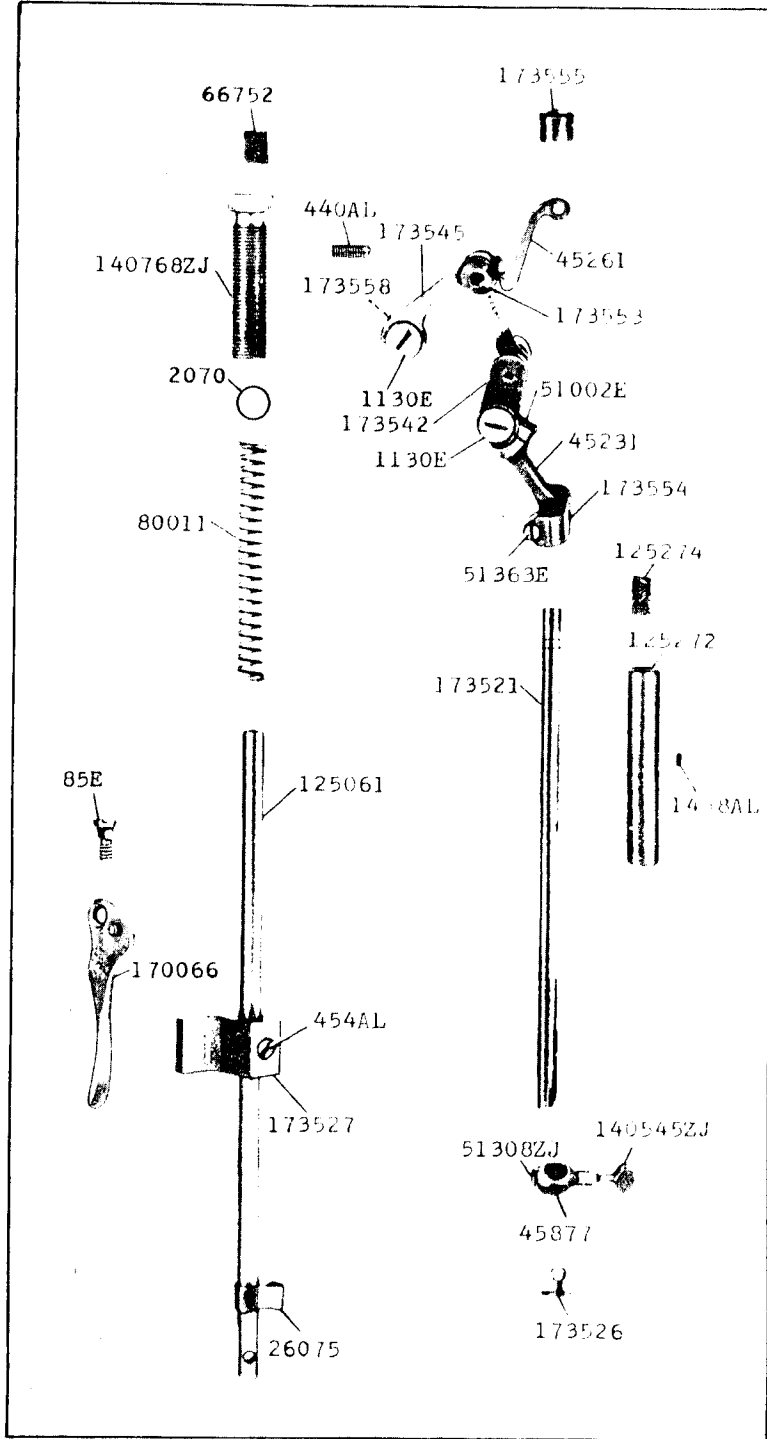

From the library of: **Patmon 2 Biddle Corp**

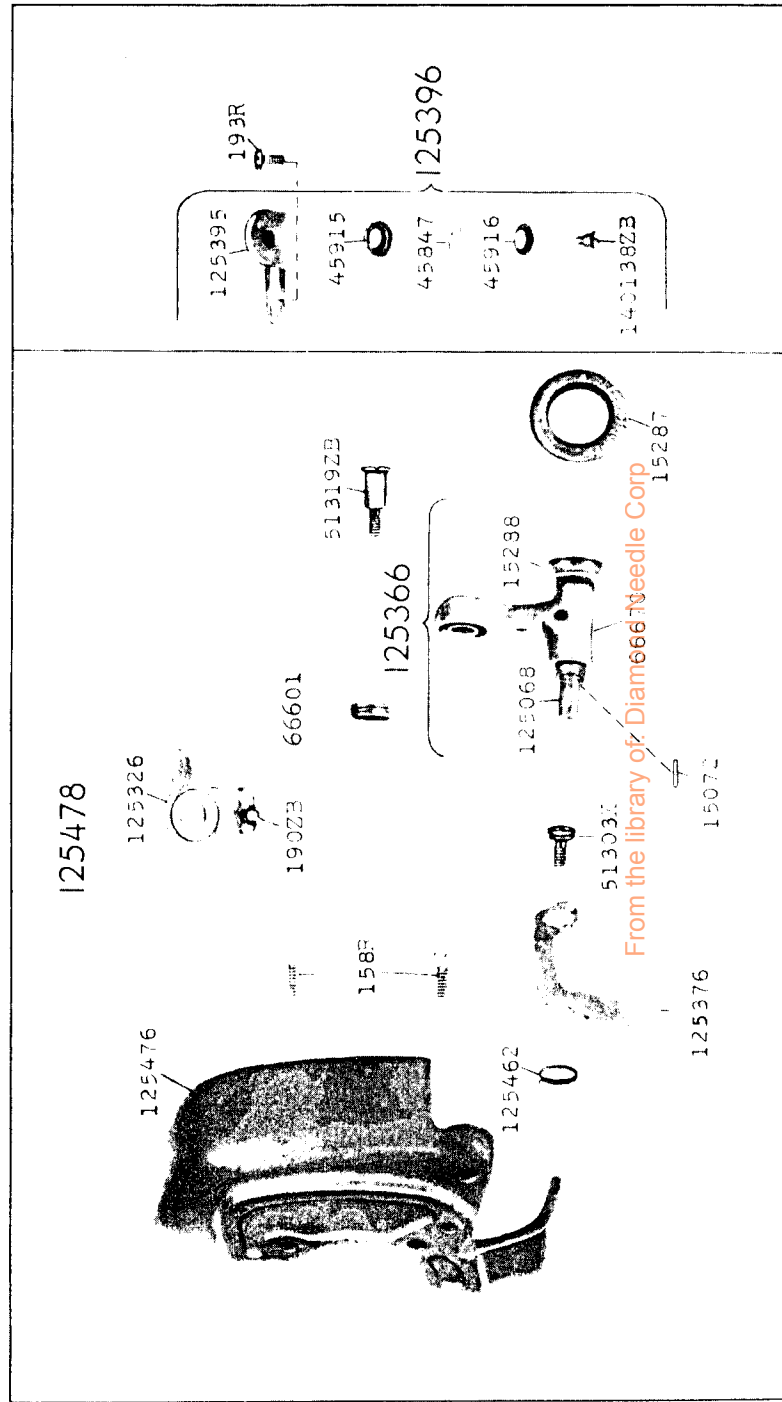
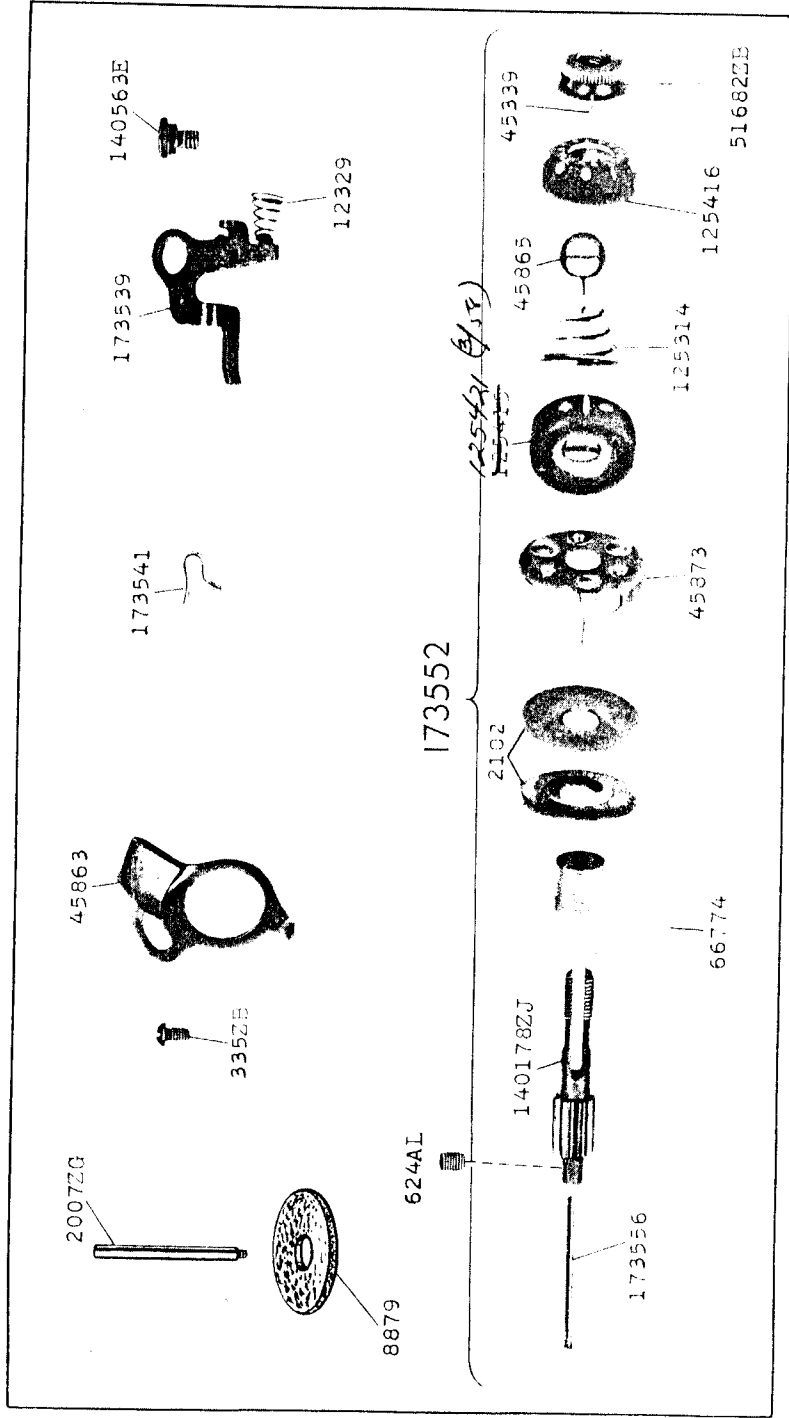

LIST OF PARTS

FOR

191K11 to 191K13 Machines

CONTENTS

	Page
Parts complete for 191K11 to 191K13 Machines	25
Attachments	33
Bobbin Winder	32
Embroidery Hoops	35
Hand Attachment	37
Numerical List of Parts	41

From the library of: Diamond Needle Corp

INSTRUCTIONS FOR ORDERING

In ordering from this List, the prefix and affix letters with the part number MUST BE quoted exactly as they are shown in the first column.

A number always indicates the same part in whatever List it may appear, or for whatever machine.

The affix letters (where shown) indicate the style of finish, as follows:—

- A. Hardened, Polished, Nickel Plated and Buffed.
- B. Polished, Nickel Plated and Buffed.
- C. Hardened only.
- D. Polished only.
- E. Soft, Not Polished.
- F. Hardened and Polished.
- G. Bright Rumbled and Nickel Plated.
- H. Blued.
- J. Nickel Plated only.
- K. Hardened and Nickel Plated.
- L. Brass Plated.
- M. Oxidized.
- R. Phosphate Coating Formed on Surface of Iron or Steel.
- S. Cadmium Plated.
- T. Copper Plated.
- U. Zinc Plated.
- V. Silver Plated.
- W. Polished and Nickel Plated.
- X. Black Oxide for Iron and Steel.
- Y. Black Nickel Plated only.
- Z. Chromium Plated.
- A.A. Buffed and Chromium Plated.
- A.B. Hardened, Polished, Buffed and Chromium Plated.
- A.E. Hardened, Bright Rumbled and Nickel Plated.
- A.F. Hardened, Bright Rumbled, Nickel Plated, Bright Rumbled and Chromium Plated.
- A.G. Alumilite (Plain).
- A.H. Alumilite (Dyed). Colour must be stated.
- A.J. Polished, Nickel Plated and Chromium Plated.
- A.K. Hardened, Polished, Nickel Plated and Chromium Plated.
- A.L. Heat Treated for Toughness.
- A.L.D. Heat Treated for Toughness and Polished.
- A.L.X. Heat Treated for Toughness and Black Oxide.
- A.S. Black Moulded Phenolic.
- A.T. Beige Moulded Phenolic.
- A.U. Brown Moulded Phenolic.
- A.W. Hardened then Flame Coated with Tungsten Carbide.
- B.A. Chrome Nickel, Satin Finish.
- B.B. Hardened and Chrome Nickel, Satin Finish.
- C.R. Hardened and Phosphate Coating Formed on Surface of Steel.
- C.U. Hardened and Zinc Plated.
- F.J. Hardened, Polished and Nickel Plated.
- T.A. Hardened, Polished, Copper and Nickel Plated and Buffed.
- T.B. Copper and Nickel Plated and Polished.
- T.J. Copper and Nickel Plated only.
- T.K. Hardened, Copper and Nickel Plated.
- T.L. Copper and Brass Plated.
- T.M. Copper Plated and Oxidized.
- X.C. Hardened and Black Oxide for Iron and Steel.
- Z.A. Hardened, Polished, Nickel Plated, Buffed and Chromium Plated.
- Z.B. Polished, Nickel Plated, Buffed and Chromium Plated.
- Z.C. Hardened and Chromium Plated.
- Z.D. Polished and Chromium Plated.
- Z.G. Bright Rumbled, Nickel Plated, Bright Rumbled and Chromium Plated.
- Z.J. Nickel and Chromium Plated.
- Z.T. Copper and Chromium Plated.

Parts marked with an asterisk (*) are furnished only when the repairs are made at Factory.

PARTS COMPLETE

FOR

Nos. 191K11 to 191K13 MACHINES

Lock Stitch ; C.B. Oscillating Shuttle ; Reversible Feed ; Link Take-up ;
Feed Throw-out Device for Darning and Embroidery.
For Family Use.

No.	Plate				
*173601		Arm
NOTE: Arm cannot be supplied separately and can only be sent as a unit, Arm and Bed assembled.					
(†) 173501		Arm and Bed, complete	Nos. 81440, 125331, 125334 and four 1405431		
2002	26000	"	Dowel Pin (2)
125331	26000	"	Oil Pad (felt), for oiling Arm Shaft Back Bearing
81440	26000	"	Spring	10/62	...
125334	26000	"	Cap
138c	26000	"	Screw (3)
173601		"	Shaft
173502	26000	"	"	173604 with 125045, 173503 and 173600	10/62
173503	26000	"	"	Bushing	...
135a1	26000	"	"	Set Screw	...
(†) 125466	26001	"	Side Cover
NOTE: In ordering it is necessary to state Colour of Machine.					
51224zb	26001	Arm Side Cover	Thumb Screw
2007zg	26007	"	Spool Pin
*173602		Bed
NOTE: Bed cannot be supplied separately and can only be sent as a unit, Arm and Bed assembled.					
256zb	26000	Clamp Stop Motion	Clamp Screw
248za	26000	"	"	Stop Screw	...
171502	26000	"	"	Washer	...
*15312		"	"	Flanged Bushing	...
15313	26000	"	"	"	15312 with two 462a1
2022		"	"	"	Pin
462a1	26000	"	"	"	Set Screw
15314		Clamp Stop Motion, complete	Nos. 248za, 256zb, 15313 and 171502 (for Agents only)

From the library of Diamond Needle Corp

† In ordering it is necessary to state Colour of Machine.

No.	Plate	
125021	26000	Crank Connecting Rod with 125044 and two 896al <i>1/2 (8.30) 1</i>
10978y (330) 896al	26000	" " " " " " " "
375c	26000	" " " " " " " "
1518r	26000	" " " " " " " "
125044	26000	" " " " " " " "
173504	26000	Face Plate for 173505 ...
173572	26002	" " " " 173573 ...
173505	26002	" " " " complete, Nos. 173504, two each 32755 and 125124 <i>with black m</i>
173573	26002	" " " " complete, Nos. 173572, two each 32755 and 125124 (for Two-Tone finish machines)
14099126	26002	Face Plate Screw ...
32755	26002	" " " " Thread Guard ...
173572	26002	" " " " " " 32755 with 125124 (for Agents only)
125124	26002	" " " " " " Rivet ...
51224	26002	" " " " " " Thumb Screw ...
173508	26001	Feed Bar ...
1904	26004	" " " " Roller ...
1813	—	" " " " and Stud, Nos. 1904 and 125060 ...
*125060	—	" " " " Stud ...
315c	26004	" " " " Screw Centre ...
15415	—	" " " " " " 315c with 1519r (2) ...
1519r	26004	" " " " " " Nut ...
125015	26000	Feed Cam and Counterbalance with 1285al ...
1285al	26000	" " " " " " Position Screw ...
173509	26003	Feed Dog, 12 teeth (14 teeth to the inch) ...
208al	26003	" " " " Screw (2) ...
125262	26000	Feed Forked Connection with 175al ...
125340	—	" " " " " " 125262 with 125335 ...
175al	26000	" " " " " " Adjusting Screw ...
1381c	26000	" " " " " " Hinge Screw (eccentric) ...
1520r	26000	" " " " " " " " Nut ...
125017	26000	" " " " " " Slide Block ...
125335	—	" " " " " " " " 125017 with 1085e ...
1085e	26000	" " " " " " " " Screw Stud ...
173510u	26004	Feed Lifting Rock Shaft ...
173511	—	" " " " " " with Feed Throw-out Assembly, complete, Nos. 173510u, 173513 and 173520 ...
173512	26004	Feed Lifting Rock Shaft Crank with 704x and 50150al ...
172(804) 704x	26004	" " " " " " Clamping Screw ...
173513	—	" " " " " " with Feed Throw-out Lever, complete, Nos. 173512 and 173515 to 173517u ...

† In ordering it is necessary to state Colour of Machine.

No.	Plate	
125048	26004	Feed Lifting Rock Shaft Centre (left) ...
125049	26001	" " " " " " (right) ...
51246al	26004	" " " " " " Set Screw (2) ...
125397	26000	Feed Regulator ...
125398	—	" " " " 125397 with 125381 ...
50353e	26000	" " " " Hinge Screw ...
125399	26000	" " " " " " Friction Washer ...
15305	26001	Feed Reversing Handle ...
125381	—	" " " " " " 45305 with 1550r ...
1550r	26001	" " " " " " Lock Nut ...
125270u	26004	Feed Rock Shaft ...
125048	26004	" " " " " " Centre (left) ...
125049	26001	" " " " " " (right) ...
51246al	26004	" " " " " " Set Screw (2) ...
173511	26001	Feed Throw-out Knob with 442al ...
173511	26001	" " " " " " Set Screw ...
173547	26004	" " " " " " Shaft and Bobbin Winder Spool Pin ...
173515	26001	" " " " " " Lever with 1813 ...
173516	26004	" " " " " " Tension Spring ...
173517u	26004	" " " " " " " " Hinge Stud ...
50150al	26004	" " " " " " " " Set Screw ...
173518u	26004	" " " " " " Pitman Rod ...
21202j	26004	" " " " " " Washer (2) ...
140138j	26004	" " " " " " Screw (2) ...
173519x	26004	" " " " " " Plunger ...
173520x	26004	" " " " " " Bracket ...
125473	26000	Hand Wheel (disc, 2 1/2" pulley) for 191K11 Machine ...
125474	26000	" " " " (spoked, 2 1/2" pulley) for 191K12 Machine ...
120855	2827	Hemmer (foot) 3 1/2" hem (packed with accessories) for 191K13 Machine ...
161673	—	Leaf Cover Protector (when ordering, colour required must be stated) ...
*125272	26005	" " " " Busting ...
125273	—	" " " " " " 125272 with 125274 ...
125274	26005	" " " " " " Oil Pad (felt) ...
1498al	26005	" " " " " " Set Screw ...
45231	26005	" " " " " " Connecting Link with 51002e ...
173524	—	" " " " " " 45231 with 173554 ...
51002e	26005	" " " " " " Adjusting Screw ...
173554	26005	" " " " " " Stud with 51363e ...

† In ordering it is necessary to state Colour of Machine.

Return the library of: Diamond Needle Corp

3/51

191K11 to 191K13 MACHINE PARTS

No.	Plate	
51363c	26005	Needle Bar Connecting Stud Set Screw
173600	26000	" " Crank with 1036al and 1293al
1293al	26000	" " " Position Screw
173555	26005	" " Hole Plug
45877	26005	Needle Clamp Body with 140545zc
45878	-	" " " 45877 with 51308zj
173526	26005	" " Gib and Thread Guard
51308zj	26005	" " Position Screw
140545zc	26005	" " Thumb Screw
140543L	-	Number Plate Drive Screw
125280u	26004	Oscillating Rock Shaft with 125056 <i>n/c 2</i>
125048	26004	" " " Centre (left)
51246al	26004	" " " " () Set Screw
125049	26004	" " " " (right)
51246al	26004	" " " " () Set Screw
125056	26004	" " " " Oil Wick (braided cotton) <i>n/c 2</i>
125500	26004	Oscillating Shaft
*171533	-	" " " 125500 with 2049 and 125295
*171531	-	" " " 171533 with 125283, 125298 and two 51229e
*125282u	-	" " " Crank
*125283	-	" " " 125282u with 162al and 125330
125284	26004	" " " 125282u with 125330 and two 162al
2049	-	" " " Pin
462al	26004	" " " Set Screw
*15170	-	" " " Slide Block
125330	26004	" " " " 15170 with 125060
*125060	-	" " " " Stud
125061	26005	Presser Bar
173527	26005	" " Guide Bracket with 154al
454al	26005	" " " " Set Screw
170066	26005	" " Lifter
85c	26005	" " " Hinge Screw Stud
80011	26005	" " Spring
2070	26005	" " " Washer
45329	-	Presser Foot Hinge Pin
*45319	-	" " Plate
*32774	-	" " Shank
45321	26003	Presser Foot (hinged), complete, Nos. 32774, 45319 and 45329
51224zb	26003	" " Thumb Screw
*140768zb	26005	Pressure Regulating Thumb Screw
173557	-	" " " 140768zb with 66752
66752	26005	" " " Plug (felt)

*3/19
(for agents only) ↑*

191K11 to 191K13 MACHINE PARTS

No.	Plate	
2518	26006	Shuttle Bobbin <i>(in mb. of pack of accessories) 3/19</i>
125287	26006	" " Case Latch
125320	26006	" " " Lever
2974	26006	" " " " Fulcrum Pin
2975	26006	" " " " Spring
592e	26006	" " " " Stop Screw
125288	26006	" " " Hinge, Nos. 2974, 125287 and 125320
125291	26006	" " " <i>592e, 2975 and 125288, case 93 3/19</i>
125292	26006	" " Body
591f	26006	" " Tension Regulating Screw
125293	26006	" " Spring
125294	26006	Shuttle , 1 1/16" diam., complete, Nos. 2518, 125291 and 125292
*125295	-	Shuttle Driver
125297	26004	" " " 125295 with two 1253al
125322	-	" " " 125297 with 125298 and two 51229e (for Agents only)
125298	26004	" " Cushion Spring
51229e	26004	" " " " Screw
2049	-	" " Pin
1253al	26004	" " " Set Screw
173570	26006	Shuttle Race Body with two 125301
173529	26006	" " Cap
662j	26006	" " " Screw
173530	26006	Shuttle Race , complete, Nos. 173529, 173532a, 173533e, 173535, 173551, 173570, two each 662j, 1289k and 173536 to 173538 (for Agents only) <i>n/c 2</i>
*173531	-	Shuttle Race 173530 with 125292 <i>(for agents only)</i>
173532u	26006	" " Gate
173533e	26006	" " " Hinge Bracket
173551	26006	" " " " Hinge Pin
173535	26006	" " " " Spring
173536	26006	" " " Latch
1289k	26006	" " " " Screw
173537	26006	" " " " Spacer
173538	26006	" " " " Spring
125301	26006	" " " Position Pin
145j	26006	" " " Screw (2)
125336	26003	Shuttle Race Slide
125337	26003	" " " Spring
51282zj	26003	" " " " Screw
125338	26003	Shuttle Race Slide , complete, Nos. 125336, 125337 and two 51282zj

From the library of: Diamond Needle Corp

No.	Plate					
45863	26007	Slack Thread Regulator and Tension Thread Guide
335 2	26007	" " " Screw
†125475	26001	Stitch Indicator Plate
335 2	26007	" " " Screw (2)
125481	26001	" Regulating Plate
125479	...	" " " 125481 with 45310, 51312zb, 125400
			and 125475
51312zb	26001	" " Thumb Screw
125400	26001	" " " Friction Washer
45310	26001	" " " Washer (fibre)
3/58 2102	26007	Tension Disc
125415 † 125415	26007	" Indicator
125415 † 125415	26007	" " Flange
45865	26007	" " " Stop Washer
51682zb	26007	" Regulating Thumb Nut with 45339
45339	26007	" " " Engaging Pin
173539	26007	" Releasing Lever
140563e	26007	" " " Hinge Screw
12329	26007	" " " Spring
173556	26007	" " Pin
125314	26007	" Spring
140178zj	26007	" Stud
45352	-	" " 140178zj with 51682zb
624al	26007	" " Set Screw
173552	26007	Tension (graduated) complete, Nos. 45352, 45865, 45873, 66774,
		125314, 125415, 125416, 173556 and two 2102
26075	26005	Thread Cutter and Holder
173541	26007	Thread Guard (head of arm, upper)
173542	26005	Thread Take-up Crank
173566	-	" " " 173542 with 1130e and 173524
1036al	26000	" " " Set Screw
45261	26005	Thread Take-up Lever
173563	-	" " " 45261 with 173545 and 173553
173564	-	" " " complete, Nos. 1130e, 173558 and	173563
173565	-	" " " 173564 with 173566
1130e	26005	" " " Cap Screw
173553	26005	" " " Hinge Stud
173545	26005	" " " Link
173558	26005	" " " Hinge Stud
1130e	26005	" " " " Cap Screw
440al	26005	" " " " Set Screw

† In ordering it is necessary to state Colour of Machine.

No.	Plate					
66774	26007	Thread Take-up Spring
343 45873	26007 10/62	" " " Thread Guard
173585za	26003	Throat Plate for 173509
691za	26003	" " " Screw (2)
140543L	—	Trade Mark Drive Screw
425029	—	Drip Pan (for Cover Set)

Bobbin Winder

For Hand Wheels Nos. 32672, 125473 and 173548

No.	Plate	
15072	26000	Bobbin Position Pin 10/62
†125476	26009	Bracket (belt cover)
109779 (P09) 158j	26009	10/62 " Screw (2)
†66670	26009	Frame
125366	26009	" 66670 with 173770-001 and 125008-173656 10/62
51319r	26009	" Hinge Screw
66601	26009	" Spring
10/62 33730	—	Friction Ring (vinyl)
173770-001	—	Pulley (Colour Code No. 701)
173656 125068	26009	Spindle with 15072 10/62
125376	26009	Stop Latch
51303x	26009	" " Hinge Screw
125462	26009	" " Spring
125395	26009	Tension Bracket
125396	26009	" " complete, Nos. 45847, 45915, 45916, 125395 and 140138zb
7/60 193zb	26009	" " Screw
45915	26009	" Disc
45916	26009	" " Screw Washer
45847	26009	" " Spring
140138zb	26009	" Screw
125326	26009	Tripping Arm
190r	26009	" " Screw
†125478	26009	Bobbin Winder (automatic), complete, Nos. 190r, 15287, 51303x, 51319r, 66601, 125326, 125366, 125376, 125462 and 125476

† In ordering it is necessary to state Colour of Machine.

Art Work and Darning

No.	Plate	
85893	2827	Embroidery Foot (for art work)
121094	2719	Darning Foot (spring)

Cording Feet

For Edge Stitching, Cording and Slide Fastener Work

No.	Plate	
160845	2719	Presser Foot (left toe)
160846	2719	" " (right toe)
140728	2719	Presser Foot Adjusting Thumb Screw
161122	2719	" " " " " Spring
161123	—	" " Hinge Pin
161124	—	" " Plate
161125	—	" " Shank (adjustable)
161126	—	" " " (stationary)
161127	2719	Presser Foot (hinged, adjustable) for sewing on the right or left side of the needle, complete, Nos. 140728 and 161122 to 161126

Imitation Hemstitching Attachment

No.	Plate	
120687	2827	with Yielding Presser Plate

From the library of: Diamond Needle Corp

ATTACHMENT SET No. 161324

161324

(Packed in Cardboard Box)

(For all countries except Denmark, Norway, Sweden and Switzerland)

No.	Plate	Description
121464	2574	Binder ...
25527b	2719	Cloth Guide ...
50053b	2719	" " Thumb Screw ...
121441	2574	Gathering Foot (double toe) ...
161307	—	Needle Threader (wire) ...
15 x 1	—	Needles (6) three each sizes 11 and 14 ...
161127	2719	Presser Foot (hinged, adjustable) for sewing on the right or left side of the needle, complete ...
86642	2574	Ruffler ...
25537	2574	Screw Driver (machine) ...
120378	2574	" " (bobbin case) ...
8879	2574	Spool Pin Washer (cloth) ...
120861	—	Tin of Oil (3 oz.) ...
161324	—	Attachment Set, complete, Nos. 25527b, 25537, 50053b, 86642, 120378, 120861, 121441, 121464, 161127, 161307, two 8879 and six needles 15 x 1 (three each sizes 11 and 14) ...
161809	—	Tube of Oil (Textless) ...

ATTACHMENT SET No. 161325

(Packed in Cardboard Box)

(For Denmark, Norway, Sweden and Switzerland)

This is the same as Set No. 161324 with the following addition:

No.	Plate	Description
121094	2719	Darning Foot ...
161325	—	Attachment Set, complete, Nos. 25527b, 25537, 50053b, 86642, 120378, 120861, 121094, 121441, 121464, 161127, 161307, two 8879 and six needles 15 x 1 (three each sizes 11 and 14) ...
120914	2827	Feller (foot) ...
120687	2827	Imitation Hemstitching Attachment with Yielding Presser Plate ...
35932	2719	Quilter ...
121170	909	Ruffler Shirring Plate ...
25539	2719	Stiletto ...
36583	2827	Tucker ...
121547	909	Under Braider ...
36865	2574	Edge Stitcher ...
35931	2574	Hemmer (adjustable) ...
120861	—	Gathering Foot (slotted) ...
120861	—	Tin of Oil (3 oz.) ...

Embroidery Hoops

(Plain)

(Birch)

No.	Plate	Description
101336	—	Hoop (inner) ...
101337	—	" (outer) ...
87586	—	" (round) 5 3/8" diam. x 7 m high, Nos. 101336 and 101337 ...
101346	—	" (inner) ...
101347	—	" (outer) ...
96410	—	" (round) 4" diam. x 7 m high, Nos. 101346 and 101347 ...
101338	—	" (inner) ...
101339	—	" (outer) ...
87589	2659	" (round) 8" diam. x 7 m high, Nos. 101338 and 101339 ...
101340	—	" (inner) ...
101341	—	" (outer) ...
87593	—	" (round) 10" diam. x 7 m high, Nos. 101340 and 101341 ...
101342	—	" (inner) ...
101343	—	" (outer) ...
87595	—	" (round) 12" diam. x 1/2" high, Nos. 101342 and 101343 ...
101358	—	" (inner) ...
101359	—	" (outer) ...
96422	2659	" (oval) 9" x 4 1/2" x 7 m high, Nos. 101358 and 101359 ...
101344	—	" (inner) ...
101345	—	" (outer) ...
87597	—	" (oval) 12" x 5 1/2" x 7 m high, Nos. 101344 and 101345 ...

Embroidery Hoops

(With Spring)

(Birch)

No.	Plate	Description
101364	—	Hoop (inner) for 101246 ...
101365	—	" (outer) with Spring, for 101246 ...
101246	—	" (round) 10" diam. x 7 m high, Nos. 101364 and 101365 ...

From the library of: Diamond Needle Corp

Hand Attachment

No.	Plate								
†94050	2284	Body
†94027	2284	" Bracket
183e	2114	" " Screw
†94028	2114	Crank Handle (wood) ^{7/60}
94029b	2114	" " Spindle
94030b	2114	" " Flange (loose) ⁴⁻⁶⁰
94069	2114	" Hinge Pin
94031a	2284	" Lever
94032	2114	" " Lock Pin
94033b	2114	" " " " Head
55531	2114	" " " " Spring
94034b	—	Crank , complete, Nos. 94028, 94029b, 94030b ⁴⁻⁶⁰ and 94031a
†94046	2114	Driver
94070	—	" 94046 with 80028 and 94048
94036	2114	" Finger
94039	2114	" " Driving Pad (raw-hide)
94040	2114	" " " " Plate
SS567e	2114	" " " " and Plate Binding Screw
94041	—	" " 94036 with SS567e, 94039 and 94040
94044	2114	" " Hinge Pin
94037	2114	" " Latch
SS565e	2114	" " " " Screw Stud
94038	2114	" " " " Spring
94076	—	Gear
†94051	2284	Gear with 94076 1/62...
†94016	2284	" Cover
399a	2114	" " Screw
SS599f	2114	" " Screw Stud
94048	2114	Pinion
80028	2114	" Dowel Pin
SS600f	2114	" " Screw Stud (eccentric)
†94052	2284	Hand Attachment , complete, Nos. SS565e, SS566c, SS599f, SS600f, 94016, 94027, 94034b, 94037, 94038, 94041, 94044, 94050, 94051, 94069, 94070, two each 183e and 399a
†SS566c	2114	Hand Attachment Screw

† In ordering it is necessary to state Colour of Machine.

Numerical List of Parts

No.	Plate	
85e	26005	Presser Bar Lifter Hinge Screw Stud ...
NN95j	2399	Embroidery Hoop Clamping Bracket Screw Nut for 101349, 101351, 101353, 101355, 101357, 101361 and 101363 ...
138e	26000	Arm Screw <i>for 173501... 10/62</i> ...
145j	26006	Shuttle Race Screw ...
150	26009	Bobbin Winder Bracket Screw <i>for 109779 (P69) 10/62</i> ...
172(809)	—	Feed Lifting Rock Shaft Crank Clamp- ing Screw for 173512 ... <i>10/62</i>
183e	2114	Hand Attachment Body Bracket Screw for 94052 ...
190r	26009	Bobbin Winder Tripping Arm Screw for 125478 ...
<i>7/60</i>	<i>1932b</i>	190r 26009 Bobbin Winder Tension Bracket Screw ...
208a1	26003	Feed Dog Screw ...
248za	26000	Clamp Stop Motion Clamp Stop Screw for 15314 ...
256zb	26000	Clamp Stop Motion Clamp Screw for 15314
315c	26004	Feed Bar Screw Centre for 15445 ...
335r	26007	Slack Thread Regulator Screw ...
335x	26001	Stitch Indicator Plate Screw ...
375c	26000	Crank Connecting Rod Hinge Screw
399a	2114	Hand Attachment Gear Cover Screw for 94052 ...
435a1	26000	Arm Shaft Bushing Set Screw ...
440a1	26005	Thread Take-up Lever Link Hinge Stud Set Screw ...
<i>Can. order 624(P30)</i>	442a1	26004 Feed Throw-out Knob Set Screw for 173514
<i>10/62</i>	454a1	26005 Presser Bar Guide Bracket Set Screw for 173527 ...
462a1	26000	Clamp Stop Motion Flanged Bushing Set Screw for 15313 ...
462a1	26004	Oscillating Shaft Crank Set Screw for 125283 and 125284 ...
SS528j	2399	Embroidery Hoop Clamping Bracket Screw for 101349, 101351, 101353, 101355, 101357, 101361 and 101363 ...
SS565e	2114	Hand Attachment Driver Finger Latch Screw Stud for 94052 ...
<i>7/60</i>	†SS566c	2114 Hand Attachment Screw for 94052 ...
SS567e	2114	Hand Attachment Driver Finger Driving Pad and Plate Binding Screw for 94041 ...
591f	26006	Shuttle Tension Regulating Screw <i>for 125291 3/59</i> ...

† In ordering it is necessary to state Colour of Machine.

No.	Plate	Description
592c	26006	Shuttle Bobbin Case Latch Stop Screw for 125291
SS599f	2114	Hand Attachment Gear Screw Stud for 94052
SS600f	2114	Hand Attachment Pinion Screw Stud (eccentric) for 94052
10/62	024(830)	Feed Throw-out Knob Set Screw for 173514
691za	26003	Throat Plate Screw
704x	26004	Feed Lifting Rock Shaft Crank Clamping Screw for 173512 <i>No. Can. order 172 (804) 10/62</i>
896al	26000	Crank Connecting Rod Cap Screw for 125021 <i>No. Can. order 10/62</i>
1036al	26000	Thread Take-up Crank Set Screw for 173600 <i>10/62 10/62 (P2)</i>
1085e	26000	Feed Forked Connection Slide Block Screw Stud for 125335 <i>10/62</i>
1130e	26005	Needle Bar Connecting Link Cap Screw for 173504 <i>3/59</i>
1253al	26004	Shuttle Driver Set Screw for 125297
1285al	26000	Feed Cam and Counterbalance Position Screw for 125045
1289k	26006	Shuttle Race Gate Latch Screw for 173530
1293al	26000	Needle Bar Crank Position Screw for 173600 <i>002 10/62</i>
1381c	26000	Feed Forked Connection Hinge Screw (eccentric)
1498al	26005	Needle Bar Bushing Set Screw
1518r	26000	Crank Connecting Rod Hinge Screw Nut
1519r	26004	Feed Bar Screw Centre Nut for 15445
1520r	26000	Feed Forked Connection Hinge Screw Nut
1550r	26001	Feed Reversing Handle Lock Nut for 125381
1813	—	Feed Bar Roller and Stud, Nos. 1904 and 125060 for 173515
1904	26004	Feed Bar Roller for 1813
2002	26000	Arm Dowel Pin <i>for 173501 10/62</i>
2007zg	26007	Arm Spool Pin
2022	—	Clamp Stop Motion Flanged Bushing Pin
2049	—	Oscillating Shaft Crank Pin for 171533
2049	—	Shuttle Driver Pin
2070	26005	Presser Bar Spring Washer
2102	26007	Tension Disc for 173552 <i>3/59</i>
2518	26006	Shuttle Bobbin for 125294 (S) <i>(in sub., spoked w/accs)</i>
2974	26006	Shuttle Bobbin Case Latch Lever Fulcrum Pin for 125288
2975	26006	Shuttle Bobbin Case Latch Spring for 125291
8879	2574	Spool Pin Washer (Cloth) for 160810 and 160811 <i>161324 and 3/5 161325</i>
12329	26007	Tension Releasing Lever Spring

No.	Plate	Description
15072	20009	Bobbin Winder Bobbin Position Pin for 125068 <i>10/62</i>
*15170	---	Oscillating Shaft Crank Slide Block for 125330
†15287	26009	Bobbin Winder Friction Ring (rubber) for 125478 <i>No. Can. order 33730 10/62</i>
15288	26009	Bobbin Winder Pulley for 125366 <i>No. Can. order 173770 001 10/62</i>
*15312	---	Clamp Stop Motion Flanged Bushing for 15313
15313	26000	Clamp Stop Motion Flanged Bushing 15312, with two 462al, for 15314
15314	---	Clamp Stop Motion, complete, Nos. 248za, 256zb, 15313 and 171502 (for Agents only)
15445	---	Feed Bar Screw Centre 315c with 1519r
2120j	26004	Feed Throw-out Pitman Rod Washer
25525	2719	Bias Gauge
25527b	2719	Cloth Guide <i>for 161324 and 161325 3/59</i>
25537	2574	Screw Driver (machine) for 160810 and 160811 <i>161324 and 161325 3/59 order 161294 0</i>
25539	2719	Stiletto
26075	26005	Thread Cutter and Holder
32630	26002	Face Plate Thread Guard 32755 with 125424 <i>173616 (1/6) 7/26/5 7/26/5 7/60</i>
†32672	26000	Hand Wheel (disc, 3 1/2" pulley) for 191K13 Machine
32755	---	Face Plate Thread Guard for 32630 173505 and 173573 <i>173615 7/60</i>
*32774	---	Presser Foot Shank for 45321
†33730	---	Bobbin Winder Friction Ring (vinyl) for 125478 <i>10/62</i>
36583	2827	Tucker
36865	2574	Edge Stitcher for 160810 and 160811
45231	26005	Needle Bar Connecting Link with 51002e, for 173524
45261	26005	Thread Take-up Lever for 173563
45305	26001	Feed Reversing Handle for 125381
45310	26001	Stitch Regulating Thumb Screw Washer (fibre) for 125479
*45319	---	Presser Foot Plate for 45321
45321	26003	Presser Foot (hinged), complete, Nos. 32774, 45319 and 45329
45329	---	Presser Foot Hinge Pin for 45321
45339	26007	Tension Regulating Thumb Nut Engaging Pin for 51689
45343	---	Thread Take-up Spring Thread Guard for 173552 <i>10/62</i>

† In ordering it is necessary to state Colour of Machine.

No.	Plate	
45847	26009	Bobbin Winder Tension Disc Spring for 125396
45863	26007	Slack Thread Regulator and Tension Thread Guide
45865	26007	Tension Indicator Flange Stop Washer for 173552
45873	26007	Thread Take-up Spring Thread Guard for 173552 <i>U. Can. order 45343 10/62</i>
45877	26005	Needle Clamp Body with 140545zc for 45878
45878	—	Needle Clamp Body 45877 with 51308zj
45915	26009	Bobbin Winder Tension Disc for 125396
45916	26009	Bobbin Winder Tension Disc Screw Washer for 125396
50053b	2719	Cloth Guide and Under Braider Thumb Screw
50150al	26004	Feed Throw-out Lever Tension Spring Hinge Stud Set Screw for 173512
50850	26009	Face Plate Thumb Screw
50684zb	26000	Needle Bar Connecting Link Adjusting Screw for 45231
51045al	26000	Machine Hinge Connection Set Screw
4/60-51224zb	26001	Face Plate Thumb Screw
51224zb	26001	Arm Side Cover Thumb Screw
51224zb	26003	Presser Foot Thumb Screw
51229e	26004	Shuttle Driver Cushion Spring Screw for 125322 and 171534
51246al	26004	Feed Lifting Rock Shaft Centre Set Screw
51246al	26004	Feed Rock Shaft Centre Set Screw
51246al	26004	Oscillating Rock Shaft Centre (left) Set Screw
51246al	26004	Oscillating Rock Shaft Centre (right) Set Screw
51282zj	26003	Shuttle Race Slide Spring Screw for 125338
51303x	26009	Bobbin Winder Stop Latch Hinge Screw for 125478
51308zj	26005	Needle Clamp Position Screw for 45878
51312zb	26001	Stitch Regulating Thumb Screw for 125479
51319r	26009	Bobbin Winder Frame Hinge Screw for 125478
51681z	26002	Face Plate Screw
51363e	26005	Needle Bar Connecting Stud Set Screw for 173554
51682zb	26007	Tension Regulating Thumb Nut with 45339 for 45352
55531	2114	Hand Attachment Crank Lever Lock Pin Spring for 94051
66601	26009	Bobbin Winder Frame Spring for 125478
†66670	26009	Bobbin Winder Frame for 125366

† In ordering it is necessary to state Colour of Machine.

No.	Plate	
66752	26005	Pressure Regulating Thumb Screw Plug (felt) for 173557
66774	26007	Thread Take-up Spring for 173552
80011	26005	Presser Bar Spring
80028	2114	Hand Attachment Pinion Dowel Pin for 94070
81110	26000	Arm Oil Pad Spring for 173501 <i>28/62</i>
86192	—	Gathering Foot (slotted) <i>1/61</i>
86742	2574	Ruffler for 161324 and 161325 <i>11/61</i>
		× 7 ^m / _m high, Nos. 101336 and 101337
87589	2659	Embroidery Hoop (round, birch) 8" diam. × 7 ^m / _m high, Nos. 101338 and 101339
87593	—	Embroidery Hoop (round, birch) 10" diam. × 7 ^m / _m high, Nos. 101340 and 101341
87595	—	Embroidery Hoop (round, birch) 12" diam. × 7 ^m / _m high, Nos. 101342 and 101343
87597	—	Embroidery Hoop (oval, birch) 12" × 5 1/2" × 7 ^m / _m high, Nos. 101344 and 101345
†94016	2284	Hand Attachment Gear Cover for 94052
†94027	2284	Hand Attachment Body Bracket for 94052
†94028	2114	Hand Attachment Crank Handle (Alum.) for 94034b <i>1/60</i>
94029b	2114	Hand Attachment Crank Handle Spindle for 94034b
94030b	2114	Hand Attachment Crank Handle Spindle Flange (loose) for 94034b <i>4-60</i>
94031a	2284	Hand Attachment Crank Lever for 94034b
94032	2114	Hand Attachment Crank Lever Lock Pin for 94051
94033b	2114	Hand Attachment Crank Lever Lock Pin Head for 94051
94034b	—	Hand Attachment Crank, complete, Nos. 94028, 94029b, 94030b and 94031a, for 94052 <i>4-60</i>
94036	2114	Hand Attachment Driver Finger for 94041
94037	2114	Hand Attachment Driver Finger Latch for 94052
94038	2114	Hand Attachment Driver Finger Latch Spring for 94052
94039	2114	Hand Attachment Driver Finger Driving Pad (raw-hide) for 94041
94040	2114	Hand Attachment Driver Finger Driving Pad Plate for 94041
94041	—	Hand Attachment Driver Finger 94036 with SS567c, 94039 and 94040 for 94052

† In ordering it is necessary to state Colour of Machine.

No.	Plate	
94044	2114	Hand Attachment Driver Finger Hinge Pin for 94052
†94046	2114	Hand Attachment Driver for 94070
94048	2114	Hand Attachment Pinion for 94070
†94050	2284	Hand Attachment Body for 94052
†94051	2284	Hand Attachment Gear ⁹⁴⁰⁵¹ with 55531, 94032 and 94033b, for 94052
†94052	2284	Hand Attachment, complete, Nos. SS565e, SS566c, SS599f, SS600f, 94016, 94027, 94034b, 94037, 94038, 94041, 94044, 94050, 94051, 94069, 94070, two each 183e and 399a
94069	2114	Hand Attachment Crank Hinge Pin for 94052
94070	-	Hand Attachment Driver 94046 with 80028
94076	-	Hand Attachment Gear for 94051
96416	-	Embroidery Hoop (round, birch) 7" diam. × 7 ^m / _m high, Nos. 101346 and 101347
96417	-	Embroidery Hoop (round, birch) 5 ⁵ / _m " diam. × 7 ^m / _m high, Nos. 101348 and 101349
96418	2659	Embroidery Hoop (round, birch) 7" diam. × 7 ^m / _m high, Nos. 101350 and 101351
96419	-	Embroidery Hoop (round, birch) 8" diam. × 7 ^m / _m high, Nos. 101352 and 101353
96420	-	Embroidery Hoop (round, birch) 10" diam. × 7 ^m / _m high, Nos. 101354 and 101355
96421	-	Embroidery Hoop (round, birch) 12" diam. × 1 ¹ / ₂ " high, Nos. 101356 and 101357
96422	2659	Embroidery Hoop (oval, birch) 9" × 4 ¹ / ₂ " × 7 ^m / _m high, Nos. 101358 and 101359
96423	-	Embroidery Hoop (oval, birch) 9" × 4 ¹ / ₂ " × 7 ^m / _m high, Nos. 101360 and 101361
96424	-	Embroidery Hoop (oval, birch) 12" × 5 ¹ / ₂ " × 7 ^m / _m high, Nos. 101362 and 101363
96425	2399	Embroidery Hoop Clamping Bracket for 101349, 101361 and 101363
96426	2399	Embroidery Hoop Clamping Bracket for 101351, 101353, 101355, 101361 and 101363
96427	2399	Embroidery Hoop Clamping Bracket Rivet for 101349, 101351, 101353, 101355, 101361 and 101363
96844	2399	Embroidery Hoop Clamping Bracket for 101357
96845	2399	Embroidery Hoop Clamping Bracket Rivet for 101357

† In ordering it is necessary to state Colour of Machine.

No.	Plate	
101246	-	Embroidery Hoop (round, birch) 10" diam. × 7 ^m / _m high, Nos. 101364 and 101365
101336	-	Embroidery Hoop (inner) for 87586
101337	-	Embroidery Hoop (outer) for 87586
101338	-	Embroidery Hoop (inner) for 87589
101339	-	Embroidery Hoop (outer) for 87589
101340	-	Embroidery Hoop (inner) for 87593
101341	-	Embroidery Hoop (outer) for 87593
101342	-	Embroidery Hoop (inner) for 87595
101343	-	Embroidery Hoop (outer) for 87595
101344	-	Embroidery Hoop (inner) for 87597
101345	-	Embroidery Hoop (outer) for 87597
101346	-	Embroidery Hoop (inner) for 96416
101347	-	Embroidery Hoop (outer) for 96416
101348	-	Embroidery Hoop (inner) for 96417
101349	-	Embroidery Hoop (outer) with SS528j, NN95j, two 96425 and four 96427, for 96417
101350	-	Embroidery Hoop (inner) for 96418
101351	-	Embroidery Hoop (outer) with SS528j, NN95j, two 96426 and four 96427, for 96418
101352	-	Embroidery Hoop (inner) for 96419
101353	-	Embroidery Hoop (outer) with SS528j, NN95j, two 96426 and four 96427, for 96419
101354	-	Embroidery Hoop (inner) for 96420
101355	-	Embroidery Hoop (outer) with SS528j, NN95j, two 96426 and four 96427, for 96420
101356	-	Embroidery Hoop (inner) for 96421
101357	-	Embroidery Hoop (outer) with SS528j, NN95j, two 96844 and four 96845, for 96421
101358	-	Embroidery Hoop (inner) for 96422
101359	-	Embroidery Hoop (outer) for 96422
101360	-	Embroidery Hoop (inner) for 96423
101361	-	Embroidery Hoop (outer) with SS528j, NN95j, 96425, 96426 and four 96427, for 96423
101362	-	Embroidery Hoop (inner) for 96424
101363	-	Embroidery Hoop (outer) with SS528j, NN95j, 96425, 96426 and four 96427, for 96424
101364	-	Embroidery Hoop (inner) for 101246
101365	-	Embroidery Hoop (outer) with Spring, for 101246

109779(809) Bobbin Winder Bracket Screw

109784(830) Crank Connecting Rod Cap Screw for 125021

From the Library of: The Needle & Bobbin

62

No.	Plate	
120378	2574	<i>No. Cancelled, order 161295. 7/60</i> Screw Driver (bobbin case) for 160810 and 160811, <i>161324 and 161325 (3/59)</i>
120687	2827	Imitation Hemstitching Attachment with yielding presser plate
120855	2827	Hemmer (foot), $\frac{3}{4}$ " hem <i>parted with access</i>
120861	—	Tin of Oil (3 oz.) <i>for 161324 and 161325 (3/59)</i>
120914	2827	Feller (foot) <i>for 161325 (3/59)</i>
121094	2719	Darning Foot (spring)
121170	909	Ruffler Shirring Plate
121441	2574	Gathering Foot (double toe) for 160810 and 160811, <i>161324 and 161325 (3/59)</i>
121464	2574	Binder for 160810 and 160811, <i>161324 and 161325</i>
121547	909	Under Braider
125021	26000	Crank Connecting Rod with 125044 and two 806at <i>109784 (P30) 10/62</i>
125029	—	Drip Pan (for Cover Set) 3/59
125044	26000	Crank Connecting Rod Oil Pad (felt) for 125021
125045	26000	Feed Cam and Counterbalance with 1285al for 173502
125047	26000	Feed Forked Connection Slide Block for 125335
125048	26004	Feed Lifting Rock Shaft Centre (left)
125048	26004	Feed Rock Shaft Centre (left)
125048	26004	Oscillating Rock Shaft Centre (left)
125049	26004	Feed Lifting Rock Shaft Centre (right)
125049	26004	Feed Rock Shaft Centre (right)
125049	26004	Oscillating Rock Shaft Centre (right)
125050	26004	Oscillating Rock Shaft Oil Wick (braided cotton) for 125280u 10/62
*125060	—	Feed Bar Roller Stud for 1813
*125060	—	Oscillating Shaft Crank Slide Block Stud for 125330
125061	26005	Presser Bar
<i>No. Can. order 13656 10/62</i>	125068	26009 Bobbin Winder Spindle with 15072, for 125366
	125262	26000 Feed Forked Connection with 175al for 125340
125270	26004	Feed Rock Shaft
*125272	26005	Needle Bar Bushing for 125273
125273	—	Needle Bar Bushing 125272 with 125274
125274	26005	Needle Bar Bushing Oil Pad (felt) for 125273
125280u	26004	Oscillating Rock Shaft <i>with 125050 11/62</i>
*125282u	—	Oscillating Shaft Crank for 125283 and 125284
*125283	—	Oscillating Shaft Crank 125282, with 462al and 125330 for 171534
125284	26004	Oscillating Shaft Crank 125282u with 125330 and two 462al <i>(for Agents only) 3/59</i>
125287	26006	Shuttle Bobbin Case Latch for 125288

No.	Plate	
125288	26006	Shuttle Bobbin Case Hinge, Nos. 2974, 125287 and 125320 for 125291
125291	26006	Shuttle Bobbin Case <i>with 592c, 2975, and 125288 for 125291 3/59</i>
125292	26006	Shuttle Body for 125294 and 173531
125293	26006	Shuttle Tension Spring <i>for 125291 (3/59)</i>
125294	26006	Shuttle, $1\frac{1}{8}$ " diam., complete, Nos. 2518, 125291 and 125292
*125295	—	Shuttle Driver for 125297 and 171533
125297	26004	Shuttle Driver 125295, with two 1253al, for 125322
125298	26004	Shuttle Driver Cushion Spring for 125322 and 171534
125301	26006	Shuttle Race Gate Position Pin for 173570
125314	26007	Tension Spring for 173552
125320	26006	Shuttle Bobbin Case Latch Lever for 125288
125322	—	Shuttle Driver 125297 with 125298 and two 51229e (for Agents only)
125326	26009	Bobbin Winder Tripping Arm for 125478
125330	26004	Oscillating Shaft Crank Slide Block <i>15170,</i> with 125060, for 125283 and 125284
125331	26000	Arm Oil Pad (felt) for oiling Arm Shaft Back Bearing for 173501
125334	26000	Arm Oil Pad Spring Cap for 173501 10/62
125335	—	Feed Forked Connection Slide Block 125047, with 1085e, for 125340
125336	26003	Shuttle Race Slide for 125338
125337	26003	Shuttle Race Slide Spring for 125338
125338	26003	Shuttle Race Slide, complete, Nos. 125336, 125337 and two 51282zj
125340	—	Feed Forked Connection 125262 with 125335
125366	26009	Bobbin Winder Frame 66670, with <i>123437 10/62</i> 125008 for 125478
125376	26009	Bobbin Winder Stop Latch for 125478
125381	—	Feed Reversing Handle 45305 with 1550r for 125398
125395	26009	Bobbin Winder Tension Bracket for 125396
125396	26009	Bobbin Winder Tension Bracket, complete, Nos. 45847, 45915, 45916, 125395 and 140138zb
125397	26000	Feed Regulator for 125398
125398	—	Feed Regulator 125397 with 125381
125399	26000	Feed Regulator Hinge Screw Friction Washer for 125479
125400	26001	Stitch Regulating Thumb Screw Friction Washer for 125479
†125415	—	Tension Indicator for 173552

125421 10/62
(3-58) 10/62

10/62

From the library of Darmond Needle Corp

No.	Plate	
†125416	26007	Tension Indicator Flange for 173552
†125421	26007	Tension Indicator for 173552 <i>125412 10/62 3/58</i>
<i>(v/60)</i> Obsolete, use 173616		173505 and 173573 ...
125462	26009	Bobbin Winder Stop Latch Spring for 125478
†125466	26001	Arm Side Cover ...
†125473	26000	Hand Wheel (disc, 2 1/2" pulley) for 191K11 Machine ...
†125475	26001	Stitch Indicator Plate for 125479 ...
†125476	26009	Bobbin Winder Bracket (belt cover) for 125478 ...
†125478	26009	Bobbin Winder (automatic), complete, Nos. 190r, †5287 , 51303x, 51319r, 66601, 125326, 125366, 125376, 125462 and 125476 for Hand Wheels Nos. 32672, 125473 and 173548 ...
125479	—	Stitch Regulating Plate 125481 with 45310, 51312zb, 125400 and 125475 ...
125481	26001	Stitch Regulating Plate for 125479 ...
125500	26004	Oscillating Shaft for 171533 ...

† In ordering it is necessary to state Colour of Machine.

Machine, and 3/59

No.	Plate	
140138j	26004	Feed Throw-out Pitman Rod Washer Screw
140138zb	26009	Bobbin Winder Tension Screw for 125396 ...
140178zj	26007	Tension Stud for 45352 ...
140543L	—	Number Plate Drive Screw for 173501 ...
140543L	—	Trade Mark Drive Screw for 173501 ...
140545zc	26005	Needle Clamp Thumb Screw for 45877 ...
140563e	26007	Tension Releasing Lever Hinge Screw ...
140728	2719	Presser Foot Adjusting Thumb Screw for 161127 ...
*140768zb	26005	Pressure Regulating Thumb Screw for 173557
140991zb	—	Face Plate Screw ...
160810		Set of Attachments, complete, Nos. 25537, 35931, 36865, 86642, 120378, 121441, 121464, two 8879 and six needles ...
<i>Obsolete, use 161324 or 161325</i>		
160811		Set of Attachments (less needles) complete, Nos. 25537, 35931, 36865, 86642, 120378, 121441, 121464 and two 8879 ...
<i>Obsolete (3/59)</i>		
160845	2719	Presser Foot (left toe) for Edge Stitching, Cording and Slide Fastener Work ...
160846	2719	Presser Foot (right toe) for Edge Stitching, Cording and Slide Fastener Work ...
161122	2719	Presser Foot Adjusting Thumb Screw Spring for 161127 ...
161123	—	Presser Foot Hinge Pin for 161127 ...
161124	—	Presser Foot Plate for 161127 ...
161125	—	Presser Foot Shank (adjustable) for 161127
161126	—	Presser Foot Shank (stationary) for 161127
161127	2719	Presser Foot (hinged, adjustable) for sewing
161294	2574	Screw Driver (machine) for 161324 and 161325 ...
161295	2574	Screw Driver (bobbin case) for 161324 and 161325 ...
161307	—	Needle Threader (wire) for 161324 and 161325
161324	—	Attachment Set (packed in cardboard box) complete, Nos. 25527b, 25527 , 50053b, 86742, 161294, 161295, 86642, 120378, 120861, 121094, 121441, 121464, 161127, 161307, two 8879 and six needles 15 x 1 (three each sizes 11 and 14) for all countries except Denmark, Norway, Sweden and Switzerland ...
161325	—	Attachment Set (packed in cardboard box) complete, Nos. 25527b, 25527 , 50053b, 86742, 161294, 161295, 86642, 120378, 120861, 121094, 121441, 121464, 161127, 161307, two 8879 and six needles 15 x 1 (three each sizes 11 and 14) for Denmark, Norway, Sweden and Switzerland ...

The Library of Diamond Needle Corp

7-60

1/59

7/60

3/59

7/60

7/60

No.	Plate	
170066	26005	Presser Bar Lifter
171502	26000	Clamp Stop Motion Clamp Washer for 15314
*171533	—	Oscillating Shaft 125500 with 2049 and 125295 for 171534
*171534	—	Oscillating Shaft 171533 with 125283, 125298 and two 51229e
† 173501	—	Arm and Bed, complete Nos. 81140 , 125331, ^{173601, 173} 173601, 173 and four 140543L
173502	26000	Arm Shaft 173604 with 125045, 173503 and 173600-002... 10/62
173503	26000	Arm Shaft Bushing for 173502
3/54 *173504 2B	—	Face Plate for 173505
173505 2B	—	Face Plate, complete, Nos. 173504, ^{2B} two each 32755 and 125424 ^{for back machines} (3/58)
173508 ^(8/1)	26004	Feed Bar ^{173516 (1760)}
173509	26003	Feed Dog, 12 teeth (14 teeth to the inch)
173510u	26004	Feed Lifting Rock Shaft for 173511
173511	—	Feed Lifting Rock Shaft with Feed Throw-out Assembly, complete, Nos. 173510u, 173513 and 173520
173512	26004	Feed Lifting Rock Shaft Crank with 704x and 50150al for 173513
173513	—	Feed Lifting Rock Shaft Crank with Feed Throw-out Lever, complete, Nos. 173512 and 173515 to 173517 for 173511
† 173514	26004	Feed Throw-out Knob with 442a ^{624 (836)} 10/62
173515	26004	Feed Throw-out Lever with 1813 for 173513
173516	26004	Feed Throw-out Lever Tension Spring for 173513
173517u	26004	Feed Throw-out Lever Tension Spring Hinge Stud for 173513
173518u	26004	Feed Throw-out Pitman Rod
173519x	26004	Feed Throw-out Plunger
173520	26004	Feed Throw-out Plunger Bracket for 173511
173521	26005	Needle Bar
173524	—	Needle Bar Connecting Link 45231 with 173554 for 173566
173526	26005	Needle Clamp Gib and Thread Guard
173527	26005	Presser Bar Guide Bracket with 454al
173529	26006	Shuttle Race Cap for 173528
173530	26006	Shuttle Race, complete, Nos. 173529, 173532u, 173533e, 173535, 173551, 173570, two each 662j, 1289k and 173536 to 173538 for 173531

† In ordering it is necessary to state Colour of Machine.

No.	Plate	
173600	26000	Needle Bar Crank with 1036al and 1293al for 173502
*173601	—	Arm ^{for 173501} 10/62
NOTE: Arm cannot be supplied separately and can only be sent as a unit, Arm and Bed assembled.		
*173602	—	Bed ^{for 173501} 10/62
NOTE: Bed cannot be supplied separately and can only be sent as a unit, Arm and Bed assembled.		
173604	—	Arm Shaft for 173502
173615	—	Face Plate Thread Guard ³²⁷⁵⁵ with 173616 (for agents only)
173616	—	Face Plate Thread Guard Rivet for 32000 ¹⁷³⁶¹⁵ 173505zb and 173573
173656	—	Bobbin Winder Spindle for 125366
173770-001	—	Bobbin Winder Pulley for 125366

No.	Plate	
*173531	—	Shuttle Race 173530 with 125292
173532u	26006	Shuttle Race Gate for 173530
173533e	26006	Shuttle Race Gate Hinge Bracket for 173530
173535	26006	Shuttle Race Gate Hinge Bracket Spring for 173530
173536	26006	Shuttle Race Gate Latch for 173530
173537	26006	Shuttle Race Gate Latch Spacer for 173530
173538	26006	Shuttle Race Gate Latch Spring for 173530
173539	26007	Tension Releasing Lever
173541	26007	Thread Guard (head of arm, upper)
173542	26005	Thread Take-up Crank for 173566
173545	26005	Thread Take-up Lever Link for 173563
173547	26004	Feed Throw-out Knob Shaft and Bobbin Winder Spool Pin
†173548	26000	Hand Wheel (spoked, 2½" pulley) for 191K12 Machine
173551	26006	Shuttle Race Gate Hinge Bracket Hinge Pin for 173530
173552	26007	Tension (graduated) complete, Nos. ^{40343, 10/12} 45352, 45865, 45873 , 66774, 125314, ^{125415 10/12} 125416 , 125421 (3/38) 125416, 173556 and two 2102
173553	26005	Thread Take-up Lever Hinge Stud for 173563
173554	26005	Needle Bar Connecting Stud with 51363e for 173524
173555	26005	Needle Bar Hole Plug
173556	26007	Tension Releasing Pin for 173552
173557	—	Pressure Regulating Thumb Screw 110768zb with 66752
173558	26005	Thread Take-up Lever Link Hinge Stud for 173564
173563	—	Thread Take-up Lever 45261 with 173545 and 173553 for 173564
173564	—	Thread Take-up Lever, complete, Nos. 1130e, 173558 and 173563 for 173565
173565	—	Thread Take-up Lever 173564 with 173566
173566	—	Thread Take-up Crank 173542 with 1130e and 173524 for 173565
173570	26006	Shuttle Race Body with two 125301 for 173528
† 173572	26002	Face Plate for 173573
173573	26002	Face Plate, complete, Nos. 173572, two each 32755 and 173571 ^{173571 (for Two Tone finish} machines)
173585za	26003	Throat Plate for 173509

† In ordering it is necessary to state Colour of Machine.